

Type 168730

Armaturen für Schiffbau und Industrie
Valves for shipbuilding and industry



**Sturmklappe nach JIS 5 K (F-3059 R)
in Durchgangsform, mit Absperrung
aus Stahlguss**

**storm valve acc. to JIS 5 K (F-3059 R)
straight type, with shut-off device
cast steel**

Materialspezifikation:

Gehäuse: Stahlguss SC 49
Deckel: Stahlguss SC 49
Klappenteller: Rotguss JIS H 5111 - BC 6
Spindel: Edelstahl SUS403
Handrad: Grauguss JIS G 5501 - FC20

material specification:

body: cast steel SC 49
bonnet: cast steel SC 49
flap: bronze JIS H 5111 - BC 6
stem: stainless steel SUS403
handwheel: cast iron JIS G 5501 - FC 20

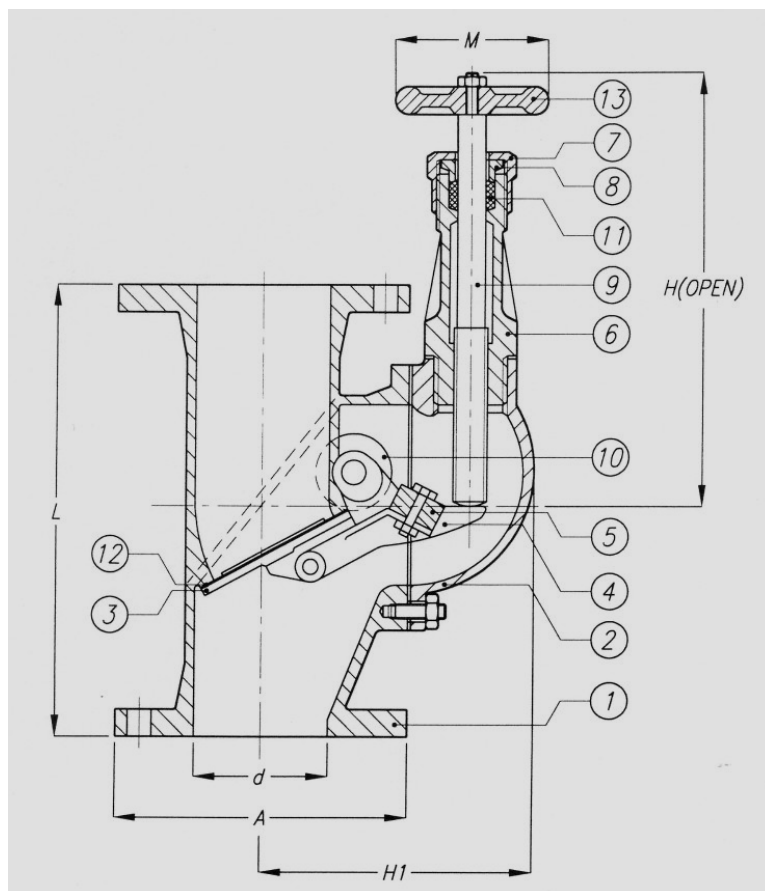

Type 168730

Zulässiger Betriebsdruck: max. 5 bar / admissible operating pressure: max. 5 bar

NW/DN	d	L	H1	H open	A	PCD	Holes	M	KG
050	050	210	130	285	130	105	4x 15	100	12
065	065	240	140	302	155	130	4 x 15	100	17
080	080	260	155	300	180	145	4 x 19	125	22
100	100	280	170	306	200	165	8 x 19	125	30
125	125	330	185	355	235	200	8 x 19	125	44
150	150	360	205	365	265	230	8 x 19	125	52
200	200	450	257	464	320	280	8 x 23	150	92